















P  **R**  **D** **O** **X**[®]
S E C U R I T Y S Y S T E M S



Максипринт Компјутери ЛТД ДОО
Бул. Туристичка бр.4, Охрид
Охридска банка Жиро сметка:
530000100483931
Контакт: 046-262 500 / 070-249 724
070-212 929
e-mail:
prodazba@maksiprint.com.mk

Wireless Alarm System DAHUA







МОДЕЛ	КАРАКТЕРИСТИКИ И СПЕЦИФИКАЦИИ	ЦЕНА СО ДАВ
	<p>DAHUA ART-ARC3000H-03-GW2(868) – Alarm KIT Supports 150 wireless peripherals Peripherals status display (signal strength, battery level, temperature, program version) Wired, Wi-Fi or GPRS network connection; Dual SIM and Single Standby, auto switching; Automatic network replenishment (ANR); Video linkage on App SOS emergency alarm; Frequency hopping function and two-way communication technology ensure communication stability; Cloud update and automatic recovery from update failure.</p>	<p>300€</p>
	<p>ARD1233-W2 - Wireless PIR detector Pet immunity function; Auto temperature compensation; 3-level sensitivity adjustment; Low battery alarm; Anti-tampering; Temperature measurement; Frequency hopping function and two-way communication technology ensure communication stability;</p>	<p>47€</p>
	<p>DAHUA ARD1731-W2 Wireless PIR-Camera Maximum resolution 1600*1200; Based on the RF-HD image transmission technology, transmission of 6 HD images with resolution of 1600*1200 needs up to 10 seconds; One-week cloud cache for videos and images; Temperature monitoring;</p>	<p>110€</p>
	<p>ARD323-W2 - Wireless door detector Signal strength detection; Low battery alarm; Temperature measurement Frequency hopping function and two-way communication technology ensure communication stability; Cloud update and automatic recovery from update failure</p>	<p>41€</p>
	<p>ARA13-W2 - Wireless outdoor siren IP65 rated; Outdoor product (-25 °C to +60 °C); 12 VDC and battery power supply. · Multiple alarm sounds: Fire, medical, intrusion, panic, and more; Sound pressure level: 110 dB; Temperature monitoring; Frequency hopping and two-way communication;</p>	<p>92€</p>
	<p>ARA12-W2 - Wireless siren Signal strength detection; Low battery alarm; Temperature measurement; Frequency hopping function and two-way communication technology ensure communication stability; Cloud update and automatic recovery from update failure.</p>	<p>46€</p>
	<p>ARA24-W2 Wireless keyfob SOS emergency alarm; Frequency hopping function and two-way communication technology ensure communication stability;</p>	<p>25€</p>
	<p>ARK30T-W2 - Wireless Keypad Supports 3 shortcut alarms: Medical, fire, emergency; Arm/Disarm with password or IC card; Supports signal strength detection to select suitable installation sites; Low battery alarm; Temperature measurement; Frequency hopping function and two-way communication; Cloud update and automatic recovery from update failure.</p>	<p>77€</p>
	<p>ARD821-W2 - Wireless Panic Button Two-way RF communication; Provides multiple LED colors to indicate different statuses; Cloud update and automatic recovery from update failure; Offers accidental press prevention; Battery life up to 5 years if used twice a week; IP54 rated</p>	<p>25€</p>
	<p>ARM310-W2 - Wireless input expander Six types of alarm: intrusion, medical, fire, emergency, gas, and tamper; NC and NO are available for alarm inputs (NO by default); Signal strength detection; Low battery alarm; Temperature monitoring; Frequency hopping function and two-way communication technology ensure communication stability;</p>	<p>31€</p>
	<p>ARA43-W2 - Alarm Repeater Connects up to 32 peripherals; Two-way RF communication; LED indicator displays device status; Supports manual and auto pairing, extending RF distance for your security system; Auto switches from dual antennas to reduce blind area; Battery backs device working for over 35 hours</p>	<p>84€</p>

	DAHUA HY-SA21A-W2(868) Wireless Smoke Alarm Split-spectrum sensor technology; Test and silence features in one single button; Loud sound output over 85 dB(A) at 3 meters; Low quiescent current consumption; Surface-mount device (SMD) circuit board design; Low battery warning signal	57€
	DAHUA HY-SAV849HA-E 5MP IR AI-fire Smoke Sensing Network Camera Remote check based on smoke sensing and video alarm linkage · Intelligent monitoring: Flame detection · With split-spectrum smoke chamber and intelligent algorithm, eliminate the false alarm effectively Built-in alarm voices, and user can import custom voices; 2/2 Alarm in/out, 1/1 audio in/out; supports max. 256 GB Micro SD card;	143€



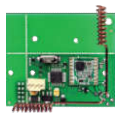

Wireless Alarm System AJAX

МОДЕЛ	КАРАКТЕРИСТИКИ И СПЕЦИФИКАЦИИ	ЦЕНА СО ДДВ
	AJAX Hub Kit Алармен систем - Централна единица (Hub) за безжичен противпровален систем со интегрирани LAN и GSM/GPRS комуникатори. Овозможено додавање и работа на до 100 безжични уреди, со до 50 корисници. Вградена back-up батерија. Комплетот содржи: алармна централа (Hub), PIR детектор на движење Ajax MotionProtect, магнетен контакт Ajax DoorProtect, далечински управувач Ajax SpaceControl. Бела боја	359€
	AJAX Hub WH / AJAX Hub BL - Централна единица Безжичнафреквенција: 868MHz; Безжичнакомуникација: Двонасочна; Макспроширивобезжични зони: 100; Вкупен број напартици: 9; Макспроширивобезжични зони: 100; wallswitch (220 VAC, 13A); (Апликација за паметни телефони); Формат надојавата вомониторинг: Ajax Translator, SIA-IP;	210€
	AJAX ReX WH / AJAX ReX BL - Zs9 - Засилувач за сигнал Безжичен репетитор на сигнал за Ajax системите, 2 пати го зголемува дострелот, напојување 220VAC, вградена back-up Литиумска 2A батерија (35 часа автономна работа само на батерија).	154€
	AJAX Keypad WH / AJAX Keypad BL - Безжична тастатури Начин на приказ: Touchsense LED; Безжичнафреквенција: 868 MHz; Безжичнакомуникација: Двонасочна;	123€
	AJAX SpaceControl WH / AJAX SpaceControl BL - Далечински управувач Начин на приказ: LED; Безжичнафреквенција: 868 MHz; Безжичнакомуникација: Двонасочна; Број на посебни алармни копчиња: 4;	38€
	AJAX DoorProtect WH / AJAX DoorProtect BL - Безжична детекција во точка Безжичнафреквенција: 868Mhz; Безжичнакомуникација: Двонасочна; Вградување: Внатрешна; Детекција: Отворање - Затворање; Метода надетекција: 1 x REED / 1 x AUX; Дострел надетекција: 20 mm; Монтажа: Надградна; Степен на сигурност:	44€
	AJAX DoorProtectPlus WH / AJAX DoorProtectPlus BL - Безжична детекција во точка Безжичнафреквенција: 868Mhz; Безжичнакомуникација: Двонасочна; Вградување: Внатрешна; Детекција: Вибрации / Отворање - Затворање; Метода надетекција: Детектор на вибрации / Reed; Дострел надетекција: 20 mm; Монтажа: Надградна; Степен на сигурност: Grade 2;	68€







	<p><u>AJAX GlassProtect WH / AJAX GlassProtect BL- Безжична детекција во точка</u> Безжичнафреквенција: 868Mhz; Безжичнакомуникација: Двонасочна; Вградување: Внатрешна; Детекција: / ; Метода надетекција: GB; Дострел надетекција: 9m; Монтажа: Таванска / Сидна; Степен насигурност: Grade 2;</p>	77€
	<p><u>Ajax Transmitter - Влезен модул</u> Модул за безжично поврзување на универзални безжични детектори (Optex BX80R, AMC Soutdoor BC исклучно) на AJAX противпровалните системи.</p>	60€
	<p><u>AJAX MultiTransmitter WH</u></p>	197€
	<p><u>AJAX MotionProtect Outdoor WH- Безжична детекција на простор</u> Безжичнафреквенција: 868Mhz; Безжичнакомуникација: Двонасочна; Вградување: Надворешна; Метода надетекција: PIR / AM; Неосетливостна домашнимиленици: <80cm; Дострел надетекција: PIR: 15m; Дострел надетекција: MW: / ; Монтажа: Сидна / Столбна; Степен насигурност: Grade 2;</p>	235€
	<p><u>AJAX MotionCam WH</u></p>	167€
	<p><u>AJAX MotionProtect WH / AJAX MotionProtect BL- Безжична детекција на простор</u> Безжичнафреквенција: 868Mhz; Безжичнакомуникација: Двонасочна; Вградување: Внатрешна; Метода надетекција: PIR; Неосетливостна домашнимиленици: <20kg, <50cm; Дострел надетекција: PIR: 12m; Дострел надетекција: MW: / ; Монтажа: Сидна; Степен насигурност: Grade 2;</p>	68€
	<p><u>AJAX MotionProtect Plus WH / AJAX MotionProtect Plus BL- Безжична детекција на простор</u> Безжичнафреквенција: 868Mhz; Безжичнакомуникација: Двонасочна; Вградување: Внатрешна; Метода надетекција: PIR / MW; Неосетливостна домашнимиленици: <20kg, <50cm; Дострел надетекција: PIR: 12m; Дострел надетекција: MW: 12m ; Монтажа: Сидна; Степен насигурност: Grade 2;</p>	105€
	<p><u>AJAX CombiProtect WH / AJAX CombiProtect BL- Безжична детекција на простор</u> Безжичнафреквенција: 868Mhz; Безжичнакомуникација: Двонасочна; Вградување: Внатрешна; Метода надетекција: PIR / GB; Неосетливостна домашнимиленици: <20kg, <50cm; Дострел надетекција: PIR: 12m; Дострел надетекција: MW: / ; Монтажа: Сидна; Степен насигурност: Grade 2;</p>	105€
	<p><u>AJAX FireProtect Plus WH / AJAX FireProtect Plus BL - Безжична детекција на состојбата на околината</u> Безжичнафреквенција: 868MHz; Безжичнакомуникација: Двонасочна; Вградување: Внатрешна; Детекција: Чад / CO / температура / нагло растење на температурата; Монтажа: Таванска; Степен насигурност: Grade 2 (EN50131-1);</p>	134€
	<p><u>AJAX FireProtect WH / AJAX FireProtect BL - Безжична детекција на состојбата на околината</u> Безжичнафреквенција: 868MHz; Безжичнакомуникација: Двонасочна; Вградување: Внатрешна; Детекција: Чад / температура / нагло растење на температурата; онтажа: Таванска; Степен насигурност: Grade 2 (EN50131-1);</p>	93€

	<p><u>AJAX LeaksProtect WH / AJAX LeaksProtect BL - Безжична детекција на состојбата на околината</u></p> <p>Безжичнафреквенција: 868MHz; Безжичнакомуникација: Двонасочна; Вградување: Внатрешна; Детекција: Поплава; Монтажа: Таванска; Степен на сигурност: Grade 2 (EN50131-1);</p>	60€
	<p><u>AJAX StreetSiren WH / AJAX StreetSiren BL - Безжични сирени</u></p> <p>Вградување: Надворешна; Безжичнафреквенција: 868 MHz; Безжичнакомуникација: Двонасочна; Звучен излез: Прилагодливо, 85-113 dB @ 1m; Трепкачко светло: LED; IP заштита: IP54;</p>	159€
	<p><u>AJAX HomeSiren WH / AJAX StreetSiren BL - Безжични сирени</u></p> <p>Вградување: Внатрешна; Безжичнафреквенција: 868 MHz; Безжичнакомуникација: Двонасочна; Звучен излез: Прилагодливо, 81-105 dB @ 1m; Трепкачко светло: LED; IP заштита: IP50;</p>	80€
	<p><u>AJAX Socket WH / AJAX Socket BL - Безжични излезни модули</u></p> <p>Намена: Приклучок за 220VAC потрошувачи, Schuko-тип F; Безжичнафреквенција: 868 MHz;</p>	93€
	<p><u>AJAX WallSwitch BL - Безжични излезни модули</u></p> <p>Намена: Приклучок за 220VAC потрошувач; Безжичнафреквенција: 868 MHz;</p>	55€
	<p><u>AJAX Relay BL - Безжични излезни модули</u></p> <p>Намена: Релеен излез; Безжичнафреквенција: 868 MHz;</p>	48€
	<p><u>AJAX ocBridge Plus - Безжични модули</u></p> <p>Намена; Безжичнафреквенција: 868 MHz; Компатибилни центри: Жичани алармни центри; Спојување на алармната централа: Релеи; Број на PGM-и – жичано: 8; Број на зони - Безжично: 99;</p>	73€
	<p><u>AJAX uartBridge Plus - Безжични модули</u></p> <p>Намена; Безжичнафреквенција: 868 MHz; Компатибилни центри: Жичани алармни центри; Спојување на алармната централа: UART; Број на PGM-и – жичано: /; Број на зони - Безжично: 99;</p>	44€









Wired Alarm System PARADOX

МОДЕЛ	КАРАКТЕРИСТИКИ И СПЕЦИФИКАЦИИ	ЦЕНА СО ДДВ
	Paradox Control Panel SP4000 Supports StayD mode; On-board Zones: 4 (8 with ATZ)-Keypad Zones: 15; Expandable to 32 zones; PGMs: 12 -2 Partitions; 4-wire expansion bus-32 User Codes; Supports PCS Series; Supports IP100 Internet Module;Wireless Expansion (RTX3), one way transmitters only;	49€
	Paradox Control Panel SP5500 Supports StayD mode; On-board Zones: 5 ; Keypad Zones: 15; Expandable to 32 zones; PGMs: 16 -2 Partitions; 4-wire expansion bus -32 User Codes; Supports PSC100 GSM Module; Supports IP100 Internet Module; Supports REM3 hand-held remote keypad	49€
	Paradox Control Panel SP6000 Supports StayD mode; On-board Zones: 8 (16 with ATZ); Keypad Zones: 15; Expandable to 32 zones; PGMs: 16; 2 Partitions; 4-wire expansion bus; 32 User Codes; Supports PSC100 GSM Module; Supports IP100 Internet Module; Supports REM3 hand-held remote keypad	71€
	Paradox Control Panel SP7000 Supports StayD mode; On-board Zones: 8 (16 with ATZ); Keypad Zones: 15; Expandable to 32 zones; PGMs: 16; 2 Partitions; 4-wire expansion bus; 32 User Codes; Supports PSC100 GSM Module; Supports IP100 Internet Module; Supports REM3 hand-held	81€







Wireless Alarm System PARADOX

МОДЕЛ	КАРАКТЕРИСТИКИ И СПЕЦИФИКАЦИИ	ЦЕНА СО ДДВ
	Paradox Wireless Control Panel MG5000 StayD Mode; Built-in transceiver (433MHz); 32 zones (any of which can be wireless); 32 users and 32 remote controls (one per user); 2 partitions; 4-wire communication bus (connect up to 15 keypads); Supports REM3 hand-held remote keypad; Supports up to 8 K32RF / K37 wireless keypads; Supports up to 2 RPT1 wireless repeaters; Supports PCS Series; Supports IP100 Internet Module; Supports VDMP3 Plug-in voice dialer; Supports 16 PGMs (any of which can be wireless);	76€
	Paradox Wireless Control Panel MG5050 StayD Mode; Built-in transceiver (433MHz); 32 zones (any of which can be wireless); 32 users and 32 remote controls (one per user); 2 partitions; 4-wire communication bus (connect up to 15 keypads); Supports REM3 hand-held remote keypad; Supports up to 8 K32RF / K37 wireless keypads; Supports up to 2 RPT1 wireless repeaters; Supports PCS Series; Supports IP100 Internet Module; Supports VDMP3 Plug-in voice dialer; Supports 16 PGMs (any of which can be wireless); In-field firmware upgrade via 307USB and WinLoad;	94€
	Paradox Wireless Console with GPRS/GSM MG6250 Simultaneous Five-channel Reporting Offers reporting viaGPRS, GSM, SMS, Voice, and traditional landline, with predefinedcommunication sequences to save installation time.; 2 partitions and up to 64 wireless zones; Supports optional quad-band GPRS/GSM module with 2 SIMcards (GPRS14); Built-in transceiver (433 MHz); Speakerphone via GSM or landline; Built-in voice and utility reporting(up to 8 telephonenumber); Two-way voice communication (via GSM or landline); 16 users and 16 remote controls; 8 wireless PGMs (2 I/Os can be hardwired);	203€
	Paradox GPRS14 Communication Plug-in Module; Accessory for the MG6250, used to support GPRS/GSM/SMS reporting; Supports 2 standard GSM provider SIM cards, for provider redundancy; Simple installation; connects directly onto PCB	100€
	Power Adapter Plug PA7 For the MG6250; Provides 7.5Vdc	16€
	Modul za internet IP150 Paradox The IP150 Internet Module is an Internet communication module that enables you to control and monitor your security system through any web browser (e.g. Internet Explorer). The IP150 provides freedom to access your system and receive email notifications anywhere in the world.	101€



Keypad Paradox



МОДЕЛ	КАРАКТЕРИСТИКИ И СПЕЦИФИКАЦИИ	ЦЕНА СО ДДВ
	<p>Paradox keypad K636 10-zone LED display; Compatible with E55, MG5000, MG5050 and Spectra SP series; Single partition keypad; StayD status LED; Patented Key Light display (button lights up to indicate an open zone); Arm, Sleep, Stay and Off keys illuminate to indicate partition status; Adjustable backlight</p>	<p>40€</p>
	<p>Paradox keypad K10 H/V 10-zone LED display; Compatible with MG5000, MG5050 and Spectra SP series; Supports StayD Mode; Separate Arm, Sleep, Stay and Off LEDs per partition; Patented Key Light display (button lights up to indicate an open zone); 1 keypad zone input; Independently set chime zones; 7 one-touch action buttons; 3 keypad-activated panic alarms; Adjustable backlight; Connects to 4-wire communication bus</p>	<p>49€</p>
	<p>Paradox keypad K32LED 32-zone LED display; Compatible with MG5000, MG5050 and Spectra SP series; Supports StayD Mode; Separate Arm, Sleep, Stay and Off LEDs per partition; In-field firmware upgrade via 307USB and WinLoad; 1 keypad zone input; Independently set chime zones; 7 one-touch action buttons; 3 keypad-activated panic alarms; Adjustable backlight; Connects to 4-wire communication bus</p>	<p>82€</p>
	<p>Paradox keypad K32LX 32-character blue LCD with programmable labels; Real-time zone alarm display (until disarmed); In-field firmware upgrade via 307USB and WinLoad; StayD status LED; 1 keypad zone input; 8 one-touch action buttons; 3 keypad-activated panic alarms; Adjustable backlight, contrast and scroll speed; Connects to 4-wire expansion bus; Compatible with MG5000, MG5050 and Spectra SP series V2.31 and up;</p>	<p>90€</p>
	<p>Paradox keypad K32RF 32-Zone Wireless LED Keypad Module; Supports StayD Mode; Built-in transceiver (433MHz); 32-zone LED display; Separate Arm, Sleep, Stay and Off LEDs per partition; In-field firmware upgrade via 307USB and WinLoad; Wireless range in a typical residential environment: 40m; 8 one-touch action buttons; 3 keypad-activated panic alarms; Adjustable backlight; Compatible with MG5000, MG5050 and Spectra SP series</p>	<p>€</p>
	<p>Paradox keypad K37 Wireless Powered by 2 "AA" batteries, with built-in backup battery (PA6 is optional), A 6Vdc power adaptor (PA6 not included) is not required but can be used as an alternative power source, 3 keypad-activated panic alarms, Built-in transceiver (433MHz), Compatible with MG6250, MG5000 / MG5050 V3.22, MG5075, Spectra SP V3.22 (except SP4000) and RTX3 V1.42</p>	<p>106€</p>
	<p>Paradox Interactive Touchscreen TM50 12.7 cm vivid color display (480 x 272 pixels); Intuitive, icon-based menus – no manual needed; Control up to 8 PGM outputs; In-field firmware upgradable via micro SD card; 1 zone/temperature input to connect a detection device or aTEMP07 (External Temperature Sensor); Customized translation via webapplication;</p>	<p>172€</p>
	<p>Paradox Interactive Touchscreen TM70 12.7 cm vivid color display (480 x 272 pixels); Intuitive, icon-based menus – no manual needed; Control up to 8 PGM outputs; In-field firmware upgradable via micro SD card; 1 zone/temperature input to connect a detection device or aTEMP07 (External Temperature Sensor); Customized translation via webapplication;</p>	<p>204€</p>
	<p>Power Adapter Plug PA6 For the K32RF and K32WK; Provides 6Vdc at 350mA max</p>	<p>16€</p>

Wired Motion Detector PARADOX



МОДЕЛ	КАРАКТЕРИСТИКИ И СПЕЦИФИКАЦИИ	ЦЕНА СО ДДВ
	Paradox 476 PRO+ Analog Single-Optic PIR; 11m x 11m and up to 15m for center beams with 88.5°viewing angle; Extremely high EMI and RFI rejection; PCB uses only surface mount components; Solid-state relay; Patented Auto Pulse Signal Processing; Automatic Temperature Compensation; Metal shield maximizes protection from EMI and RFI signals;	13€
	Paradox 476 PET P2C Analog Single-Optic PIR; Immune to animals weighing up to 18kg; 11m x 11m and up to 15m for center beams with 88.5°viewing angle; Extremely high EMI and RFI rejection; PCB uses only surface mount components; Solid-state relay Automatic Temperature Compensation; Metal shield maximizes protection from EMI and RFI signals;	18€
	Paradox NV5 High-Performance Infrared Motion Detector; Infrared motion detector managed by Full Authority Digital Electronics Control (FADEC); Paradox's Hybrid Cylindrical-Spherical 1.0" lens with 3rd generation 3D Lodiff® Fresnel segments- (10 x 10 m), 102° viewing angle, and 0.5 m to max range	16€
	Paradox DG85 Outdoor High-Security Digital Motion Detector; Impact and temperature resistant casing (-35°C to 50°C); Patented Digital Motion Detection; Extremely reliable and false-alarm free; Dual Optical Filtering System; UV protected lens; Dual optics (2 dual opposed element sensors); Digital Dual Opposed Detection; Multi-level sensitivity adjustment; Two operational modes (Bus or Relay operation)	€
	Paradox DG 457 Glassbreak Detector; Conventional solid-state relay operation; Full audio and infrasonic spectrum analysis; 7 frequency digital filters, digital amplifier gain and frequency fluctuation assessment; Impact and shock wave analysis; High-immunity to RFI and EMI signals; Adjustable sensitivity: covers up to 9m when set to high and up to 4.5m when set to low; Anti-tamper switch	30€
	Paradox DG467 360° Ceiling Mounted Digital Motion Detector; Two operational modes (addressable for the Digiplex and Digiplex EVO series or conventional relay operation); Dual opposed element sensor; Digital Detection; 7m x 6m at 2.4m; 11m x 6m at 3.7m; 360° viewing angle	€

Wireless Motion Detector PARADOX



МОДЕЛ	КАРАКТЕРИСТИКИ И СПЕЦИФИКАЦИИ	ЦЕНА СО ДДВ
	Paradox PMD2P Wireless Analog Single-Optic PIR (433MHz); Dual element sensor; Immune to animals weighing up to 18kg; 11m x 11m and up to 15m for center beams with 88.5°viewing angle; Wireless range in a typical residential environment:; 35m with MG6160, MG6130;; 70m with MG5000, MG5050 and RTX3; Patented Auto Pulse Signal Processing; Automatic Temperature Compensation;	48€
	Paradox G550 Wireless Glassbreak Detector (433MHz); 6m radius range and 360° coverage pattern protects an entire room with one sensor; Detect breaking of different types of glass including plate, tampered, laminated and wired; Standard Alkaline 3x AAA type battery with low battery supervision; Factory-set sensitivity for safer installation; Recognizes actual pattern of breaking glass across the full audio band;	139€
	Paradox PMD85 Wireless Outdoor Digital Dual-Optic PIR (433MHz); Impact and temperature resistant casing; Operates at -35°C to +50°C; UV protected lens; Dual Optical Filtering System; Multi-level sensitivity adjustment, Patented Digital Motion Detection; Dual optics (2 dual opposed element sensors).	148€

	<p>Paradox DCTXP2 2-Zone Wireless Door Contact (433MHz); 2-zonecapabilities where each zone is independent and has its own serialnumber; Zone 1 - One high-sensitivity reed switch (magnet included);Zone 2 - Universal transmitter input (N.O./N.C.); -Anti-tamper switch;Wireless range in a typical residential environment:30m with MG6160 and MG6130;60m with MG5000, MG5050 and RTX3;</p>	49€
	<p>Paradox DCT2 Ultra-Small Door Contact (433MHz); One high-sensitivity reed switch (magnet included); Anti-tamper switch; Wireless range in a typical residential environment: 20m with MG6160 and MG6130; 40m with MG5000, MG5050 and RTX3;</p>	57€
	<p>Paradox DCT10 2-Zone Long-Range Door Contact (433MHz); 2-zonecapabilities where each zone is independent and has its own serialnumber; Zone 1 - One of two high-sensitivity reed switches (magnetincluded); Zone 2 - Universal transmitter input (N.O./N.C.); Lowbattery and signal transmission LED; Anti-tamper switch; Wireless range in a typical residentialenvironment: 35m with MG6160 and MG6130; 70m with MG5000, MG5050 and RTX3;</p>	53€











Remote Control & Wireless Door Contacts

МОДЕЛ	КАРАКТЕРИСТИКИ И СПЕЦИФИКАЦИИ	ЦЕНА СО ДДВ
	<p>Paradox REM1 Remote Control with Backlit Buttons (433MHz); Water resistant; Perform up to 5 different actions; Wireless range in a typical residential environment:; 30m with all-in-one consoles and RX1; 45m with MG5000 / MG5050; 60m with RTX3</p>	31€
	<p>Paradox REM1 Emergency/Panic Remote Control (433MHz); Water resistant; Panic function allows user to instantly send panic signal to monitoring station;Includes lanyard attachment to facilitate portability; optionalwrist strap and belt clip Includes easily-replaceable CR2032 battery, with a batterylife of 3 yearswith MG6130 / MG6160 / MG6250 and RX1; 45m with MG5000 / MG5050, K32LX and K641LX; 60m with RTX3</p>	31€
	<p>PARADOX Metal Box 28cm X 28 X 8 cm; Provision for multiple module and panel mounting; Many punch-out holes for simple wiring; Easy door removal</p>	35€

GSM Home Alarm System

МОДЕЛ	КАРАКТЕРИСТИКИ И СПЕЦИФИКАЦИИ	ЦЕНА СО ДДВ
	<p>M-WG107T Tuya Smart WiFi GSM Alarm System</p> <ul style="list-style-type: none"> ◆ APP name:TuyaSmart; ◆ Work with Amazon Alexa/Google Assistance ◆ 4.3 inch touch screen LCD; ◆ Input Voltage:5V/1A ◆ Support 100 wireless detector,remote control and RFID cards; ◆ Low-battery detection/Power off detection ◆ Built in battery to enable the alarm panel continue work when no WiFi; 	201€
	<p>M-WSR201 Wireless Signal Repeater with Adapter It is a special device for extending the wireless signals; Working voltage: DC12V; Operating current: 150mA-180mA; Distance extend 500-1000m;</p>	67€











GSM HOME ALARM SYSTEM





МОДЕЛ	КАРАКТЕРИСТИКИ И СПЕЦИФИКАЦИИ	ЦЕНА СО ДДВ
	<p><u>IR202 Wireless PIR motion detector with ON/OFF switch</u> power 6F22 battery 9V, low power indication, adjustable time for alarm delay detecting, distance adjustable, automatically temp. compensation, anti-RFI & anti-EMI battery life 1-2 year, Detecting distance:12m detecting angle: 110 degrees</p>	<p>17€</p>
	<p><u>PST-PIR103 Wireless PIR Motion Sensor with Internal Antenna</u> Installation:wall-mounted; Power: AAA alkaline battery 2*1.5V; Detecting distance:12m, detecting angle:110 degrees; Open distance: 100-150m; 1527 IC; Comptiable with all alarm models above</p>	<p>19€</p>
	<p><u>M-WP002 Tuya Smart WiFi PIR Sensor</u> APP name:TuyaSmart; Battery:3V CR123A lithium battery Low-battery detection; PIR sensitivity angle:110 degree; PIR sensitivity distance:10m;</p>	<p>34€</p>
	<p><u>IR401 Wireless wide angle ceiling PIR sensor</u> ceiling mounted, 9V D.C. triple pulse, count adjustment, N.C. or N.O. for choice, automatically temp. compensation, detecting distance: φ8m, detecting angle: 360 degrees</p>	<p>31€</p>
	<p><u>DS201 Wireless Door/Window Magnetic Sensor</u> It is consisted of transmitter and magnetic part, it is used to detect door, window, or drawer if it is opened or moved , 12 Volt battery included for 3 months, it can be adhesive or by screws.</p>	<p>11€</p>
	<p><u>PB101 Wireless Panic Button</u></p>	<p>10€</p>
	<p><u>RC102 Remote controller</u> It is used to arm, disarm, emergency help, open or close the siren for the main panel Note: it is suitable for alarm host models: GSM-01, GSM-02</p>	<p>11€</p>
	<p><u>RC105D Remote controller</u> Wireless Metal Remote Controller Power: 23A 12V battery; Open distance: 100-150m; Only 2262 IC; Working for alarm model G10C ,G10A ,PG992CQ ,GA997CQN ;</p>	<p>15€</p>
	<p><u>RC201A Remote controller</u> Wireless Remote Controller Power: CR2032 3V Lithium Cell battery; Open distance: 100m; Only 1527 IC; Comptiable with G10C,G10A,GA997CQN;</p>	<p>13€</p>
	<p><u>FS201 Wireless flashing & sound siren</u> It is used with the main panel</p>	<p>28€</p>





WIRED ALARM SYSTEM

МОДЕЛ	КАРАКТЕРИСТИКИ И СПЕЦИФИКАЦИИ	ЦЕНА СО ДДВ
	<p>PC1864NKEH Alarmna centrala so 8+8 zoni(+ 8 zoni na 8 tastaturi) dellivi vo 8 PARTICII,max.8 tastaturi , 35 korisnicki sifri,memorija za 500 nastani, PC link,vgraden digitalen komunikator,4 PGM izlezi so prosiruvanje do 16,prosiruvanje do max. 64 zoni so pomos na7 PC5108 moduli, prosiruvanje so 32 bezzicni zoni so pomos naRF5108,RF5132 i RFK5501(max.4 bezzicni moduli), prosiruvanje so 64 adresabilni elementi so pomos nadva PC5100</p>	155€

WIRED HOME ALARM ACCESSORIES

МОДЕЛ	КАРАКТЕРИСТИКИ И СПЕЦИФИКАЦИИ	ЦЕНА СО ДДВ
	<p>MT-20083X Wired Gas Leakage Detector HOT! 220V A.C.. power optional,auto-test for malfunction,Alarm Output: sound &flash alarm; wall mounted</p>	22€
	<p>CO101 Wired Carbon Monoxide Detector HOT! 220V A.C.. power optional,auto-test for malfunction,Alarm Output: sound &flash alarm; wall mounted!</p>	28€
	<p>TD201 Wired Temperature Detector; 9-35VDC, NC/NO output PST-TD201- 220V A.C.. power optional,auto-test forMalfunction, Alarm Output: sound & flash alarm; wall mounted!</p>	17€
	<p>IR104 Wired photoelectric smoke detector 12V D.C, Sound & flash alarm, anti white light interference, alarm output: relay output N.O. / N.C, alarm volume: more than 85dB/m.</p>	22€
	<p>SD105 Wired photoelectric smoke detector, 12V D.C, Sound & flash alarm, anti white light interference, alarm output: relay output N.O. / N.C, alarm volume: more than 85dB/m.</p>	22€
	<p>M-RC35 Wired Recessed Door/Window Sensor</p>	2.5€
	<p>WD102 Wired Door/Window Magnetic Sensor normal</p>	2.5€
	<p>WD103 Wired Door/Window Magnetic Sensor MINI</p>	3€
	<p>NT86/NT86-1 NO/NC/COM with Light Dimension: 86L*86W*25H(mm); Weight: 0.15kg; Input: DC12V; the light will turn to green when active; sensitive distance is adjustable from 1-15cm; Optional Accessories: M86 Mounted Back Box</p>	14€
	<p>PV1 NO/NC/COM Surface Mount Ultra Narrow Size Dimension: 76L*23W*14H(mm); Weight: 0.04kg; Standard Package: 10pcs/bag; Fireproof PVC material;</p>	2.4€



	Exit Button PB02/Z30 NO/COM Small Size with Back Box Surface Mount; Dimension: 80L*30W*24H(mm); Weight: 0.14kg; Standard Package: 200pcs/carton/29kg/51*46*25cm; Zinc Alloy Plate and steel button, Wire Drawing Finished;	16€
	FAB01 Wired Fire alarm button; INSTALLATION ENVIRONMENT: INDOOR OR DRY OCCASION; MAXIMUM CURRENT ALLOWED: 3A; MAXIMUM VOLTAGE ALLOWED: 50V; LOWEST VOLTAGE: 12V	13€
	ACM-K3G Model: ACM-K3G; Dimensions : 86Lx86Wx50H(mm); Standard Structure : Fireproof Material, Easy to install; Current Rating : 3A 36VDC Max; Output Contact : NO\NC\COM; Operating temp : -10°C ~ 55°C (14°F-131°F); Suitable for Door : Exit Door, Emergence Door; Material Selection : Fireproof Material, Sandblast Finished;	12€
	ACM-K3W Model: ACM-K3G; Dimensions : 86Lx86Wx50H(mm); Standard Structure : Fireproof Material, Easy to install; Current Rating : 3A 36VDC Max; Output Contact : NO\NC\COM; Operating temp : -10°C ~ 55°C (14°F-131°F); Suitable for Door : Exit Door, Emergence Door; Material Selection : Fireproof Material, Sandblast Finished;	12€
	DEB02 Wired Door Exit Push Button	7€

INFRARED BALUSTER or BEAMS		
МОДЕЛ	КАРАКТЕРИСТИКИ И СПЕЦИФИКАЦИИ	ЦЕНА СО ДДВ
	ABO-20L Senzor Photo cell Single beam	24€
	MT-20L Senzor Photo cell	32€
	IB705 3-beam,wired,Detecting distance: 250M; length:27CM	80€
	IB805 4-beam,wired,Detecting distance: 250M; length:35CM	115€
	IB110 Wireless- wired :twin-beam,outdoor detecting distance:40M,valid length:28cm	60€



INFRARED BALUSTER or BEAMS

МОДЕЛ	КАРАКТЕРИСТИКИ И СПЕЦИФИКАЦИИ	ЦЕНА СО ДДВ
	<p>MS102 Wired siren, It directly connects to the main host; OPERATION VOLTAGE:DC6-12V; SOUND TYPE:SINGLE TONE/6-TONE; COLOR:BLACK/WHITE/RED; SIZE:54(W)×48(L)×54(H) mm</p>	<p>7.2€</p>
	<p>S103 Outdoor - Indoor Wired Sound Horn rated voltage: DC12V; rated current: 1200mA; sound level: 115dB; power: 20W</p>	<p>8€</p>
	<p>M-CA-210 Outdoor - Indoor Wired Sound Horn Power supply:DC12V; Alarm current:600-1000mA; Alarm Sound:≥120dB;; Dimension: 300*300*200mm; Tones: single tone; Fire-proof ABS or PC material available</p>	<p>16€</p>
	<p>M-CA-600S Outdoor - Indoor Wired - Sound Horn 6 Tones Black Alarm Power supply:12V Operating; Voltage:6-15VDC; Rated Current: 600/1200 mA; Tones :6 Tones- Single Power: 15W/20W SPL (Db/m)</p>	<p>14€</p>
	<p>Blinking Rotary signal lamp High bright, High transparency fadeless, low noise, bolt fastening Magnetic solution Environmentally friendly and power saving. Good vibration resistance and stable emitting. Durable and non-fading brilliant beams. Instant and immediate light on. Voltage:DC12V. Long life:50000 hours or more. Waterproof, surge protection</p>	<p>9€</p>
	<p>Red LED Lamp Flashing Light</p>	<p>9€</p>
	<p>FS106 Wired Flashing & Sound Siren</p>	<p>24€</p>
	<p>Siren CA102 flashing warning strobe & sound siren rated voltage: DC12V/24VDC/110V-220AC; rated current: 300mA; sound level: 120dB; power: 30W/40W; Strobe source: Xenon Tube/Led; flash frequency:70-90time/min</p>	<p>10€</p>
	<p>M-HC-S36A OPERATION VOLTAGE:DC 6-12V; SOUND TYPE:SINGLE TONE/6-TONE; OUTPUT POWER:10W/15W; COLOR:WHITE; SIZE:110(W)×55(L)×110(H)mm</p>	<p>11€</p>
	<p>M-SI-350 Rated Voltage: DC12V ; Operating Voltage: DC9-15V ; Rated Current: 300mA ; Strobe source: Xenon Tube/LED ; Flash Frequency: 70-90 times/minute ; Sound SPL: 110dB ; Operating temperature: -20~60°C</p>	<p>19€</p>
	<p>M-OFS-WG Wireless Outdoor Flash & Sound Siren with Backup Battery Note: only working for models: WG103, WG106, WG103T, WG107T; G30, G12. Note: Adapter included with tamper switch</p>	<p>45€</p>





	M-WG107T Wireless Outdoor Solar Siren working with PST-WG107T	53€
	PA-200 Outdoor siren with flash, 120dB (without battery) INSIDE METAL COVER FOR DOUBLE PROTECTION; MAGNETIC DYNAMIC SOUNDERS WITH 120DB AT 1M; LEN CORLORS IN RED,BLUE,ORANGE,WHITE; 3 WAY TAMPER SWITCH PROTECTION	40€
	M-SL-650R OUTER SIREN WITH STROBE LIGHT 24V Siren Voltage DC24v , Power 50W,Siren Current 1200mA , Strobe current 250mA ,Strobe freq 120-150/minute , SPL 128dB ,Lens color REDMaterial ABS/AS/PC	46€
	Paradox SR250 Wireless Siren with Built-in Strobe (433MHz); Compatible with MG Series V4.0 and SP series V4.0 whenusing an RTX3 V1.5; 100db wireless siren with integrated strobe light; Weather-resistant design using a PC/ABS enclosure with UVprotection and a silicone coated PCB (-20°C to 50°C); Battery powered only, no need for AC power; Wireless range in a typical residential environment:- 35m with MG6160, MG6130, and MG6250; 70m with MG5000, MG5050 and RTX3-2.5 hour alarm display (strobe flashes every 4 seconds afterbell cut-off);	164€
	M-ST-DC1 WIFI Smart Door Opener Relay; APP name:TuyaSmart; Work with Amazon Alexa/Google Assistance/IFTTT; Work Voltage: DC7-32V; Wifi Frequency: 2.4GHz; Relay Load: 250V/10A; Work alone, not work with alarm panel together	38€
	RTU5024 GSM Door Opener GSM Frequency , Quad-band 850/900/1800/1900MHz , Digital Output , NC/NO dry contact 3A/240VAC , Power consumption , 12V input Max. 50m A/Average 25mA , SIM Card Supporting 3V SIM Card, Temperature range -20~+60 °C, Backup battery 3.7V/900Mah; Exterior dimension 102mm*D76mm*H27mm	55€
	TTT603 GSM telephone modem GSM Dual Band, Compatible with GSM 900 /1800 MHZnetworks . Built-in Digital antenna; send and receive voice call, send and receive SMS, Interrogate your voicemail; Voice and SMS service; Information at a glance status LEDs, a new voice mailmessages and other important functions; Ring voltage: 68V; Power Supply: DC12V	53€
	TTT603 GSM telephone modem – With Battery GSM Dual Band, Compatible with GSM 900 /1800 MHZnetworks . Built-in Digital antenna; send and receive voice call, send and receive SMS, Interrogate your voicemail; Voice and SMS service; Information at a glance status LEDs, a new voice mailmessages and other important functions; Ring voltage: 68V; Power Supply: DC12V	60€
	Paradox GPRS14 Communication Plug-in Module; Accessory for the MG6250, used to support GPRS/GSM/SMS reporting; Supports 2 standard GSM provider SIM cards, for provider redundancy; Simple installation; connects directly onto PCB	80€
	Akumulator 12V - 1,3 Ah, dimenzii: 97 x 43 x 52mm (L x W x H), tezina 0.58kg	10€
	Akumulator 12V - 2,4 Ah, dimenzii: 178 x 35 x 61mm (L x W x H), tezina 1.00kg	12€
	Akumulator 12V - 4,0 Ah, dimenzii: 90 x 70 x 101mm (L x W x H), tezina 1.40kg	15€
	Akumulator 12V - 7,0 Ah, dimenzii: 151 x 65 x 93.4mm (L x W x H), tezina 2.05kg	20€
	Transformator 220VAC/16V-30VA vo zastitno kukiste so klemi I osiguruvac	19€







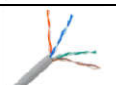

	<u>Transformator 220VAC/16.5V-45VA vo zastitno kukiste so klemi I osiguruvac</u>	24€
	<u>PC1520</u> stabilizirano napojuvanje 6/12VDC-1.5A polnac za akumulatorski baterii	28€
	<u>PC3020</u> Stabilizirano napojuvanje 6/12VDC-3A polnac za akumulatorski baterii	38€
	<u>RELE 12V</u>	3€

DAHUA Cable

МОДЕЛ	КАРАКТЕРИСТИКИ И СПЕЦИФИКАЦИИ	ЦЕНА СО ДДВ
	<u>PFM920I-5EUN – 305m UTP CAT5E Cable</u> 305m UTP CAT5E, Max.160m long distance PoE supply, 99.99% OFC (oxygen free copper) Excelent material, Environmentally friendly PVC	27ден
	<u>PFM920I-6UN-C – 305m UTP CAT6E Cable</u> 305 m (1000 ft)/carton UTP CAT6, power over Ethernet, compatible with one cable; High-purity oxygen-free copper conductor	40ден

KABEL

МОДЕЛ	КАРАКТЕРИСТИКИ И СПЕЦИФИКАЦИИ	ЦЕНА СО ДДВ
	<u>Power Cable PPL 2x0,75 CCA (for power supply)</u> 100m Black Color	20ден
	<u>Power Cable PPL 2x0,75 COOPER (for power supply)</u> 100m Black Color	25ден
	<u>FTP Cat5E - 24AWG</u> Network Cable , with aluminium foil , and transparent PET film, Conductor 0.51mm - 305m BoxGrey Color	20ден
	<u>FTP Cat5E - 24AWG so SAJLA</u> Network Cable , with aluminium foil , and transparent PET film, Conductor 0.51mm - 305m Box SO SAJLA Grey Color	30ден
	<u>FTP Cat5E 24AWG - 100% FULL COOPER</u> CU Network Cable CU (100% Copper), with aluminium foil , and transparent PET film , Conductor 0.51mm , Pass Fluke test on 100M - 305m Box Grey Color	35ден
	<u>FTP Cat6E 23AWG</u> Network Cable , with aluminium foil , and transparent PET film, Conductor 0.57mm - 305m BoxGrey Color	30ден

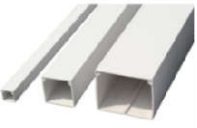
	FTP Cat6E 23AWG - 100% FULL COOPER Network Cable CU (100% Copper) , with aluminium foil , and transparent PET film , Conductor 0.57mm - 305m Box Grey Color 18.6	40ден
	ALARM CABLE 6 x 0.22, shield 100m , EXTRA	25ден
	ALARM CABLE COOPER 6 x 0.22, shield 100m , COOPER EXTRA	30ден
	PP Kabel 1*2*0.8 J-Y(st)Y	
	PP Kabel 2*2*0.8 J-H(st)H CRVEN Halogen Free	
	PP kabel 2x0,80mm COOPER , RED color	35ден
	PP kabel- Bavno gorecki –LSZH 2x0,80mm COOPER , LSZH, RED color , nezapaliva izolacija po CEI 20-22 II i IEC 323-3C standardi	40ден
	SIGNAL CABLE 2x0,75mm2+4x0,22mm 2, 4,8±0,3mm, white color for Dorephone	35ден
	Estetski Kanali (Bela Boja na kanali) 12x12 16x16 25x16 25x25 40x25 40x40 60x40	МЕТАР 28 ден 34 ден 42 ден 55 ден 85 ден 120 ден 180 ден

Цените се END USER и истите важат за крајни корисници.

Цените се претставени со пресметан ДДВ 18% .

Гаранција на производите е од 1-12 месеци.

МАКСИПРИНТ го задржува правото на промена на цените без претходна најава.